



赛旺科技 SKY WIN



www.wpcmachines.com

南京赛旺科技发展有限公司

地址：南京市沿江工业开发区汇鑫路18号 邮编：211505
电话：025-86726700 传真：025-58212235
E-mail: xawax@wpm.com.cn skywin@sw-wpc.com

www.skywinextruder.com

SKY WIN Technology Co., Ltd

Add: No.18,Huixin Rd.,Yangtze River Dev.Zone,Nanjing 211505 China
Tel: +86-25-5767 6996 Fax: +86-25-5821 2235
E-mail: skywin@wpcmachines.com



SPC、LVT、WPC
环保地板设备

SPC/LVT/WPC Flooring
Production Line

公司简介

COMPANY PROFILE >>

南京赛旺科技发展有限公司专注于塑料挤出设备制造，拥有20余年行业经验与100余项技术专利，致力于为全球客户提供高效、稳定的生产解决方案。

公司专业研发与生产：

SPC、LVT、WPC 地板挤出设备	PVC墙板、门板 挤出生产线	WPC/PVC/PE/PP异型材及 板材挤出设备
-----------------------	-------------------	-----------------------------

依托30余名海外服务工程师组成的全球技术支持团队，赛旺能够为客户提供快速响应的本地化服务。凭借持续的技术创新与丰富的项目经验，我们不断提升设备性能与自动化水平，助力客户实现高产能、高品质与可持续发展。

SKY WIN以专业的技术，服务全球，产品已远销美洲、欧洲、中东、东南亚、非洲等40多个国家及地区，以稳定可靠的设备性能，与全球客户共同践行绿色制造的商业价值。



With over 20 years of industry experience and more than 100 technical patents, SKY WIN is dedicated to providing efficient and stable production solutions for customers worldwide.

Our core product lines include:

- SPC, LVT, WPC Flooring Extrusion Lines
- PVC Wall Panel & Door Panel Extrusion Lines
- WPC/PVC/PE/PP Profile and Sheet Extrusion Lines

Supported by a global technical service team of over 30 overseas service engineers, SKY WIN ensures rapid response and localized support for customers around the world.

Through continuous technological innovation and rich project experience, we constantly improve equipment performance and automation levels, helping customers achieve high output, superior quality, and sustainable development. SKY WIN serves the world with our professional technology. SKY WIN products have been exported to more than 40 countries and regions in the Americas, Europe, the Middle East, Southeast Asia, and Africa. With stable and reliable equipment performance, SKY WIN works with global customers to realize the commercial value of green manufacturing.

公司荣誉

GLORIES OF COMPANY

20+ 年行业制造经验
20+ Years of Industry
Manufacturing Experience

100+ 项核心专利
100+ Patents

40+ 国家与地区客户
40+ Countries & Regions Served

20000+ m²现代化生产基地
20,000+ m² Modern Manufacturing Facility

30+ 资深工程师团队
30+ Experienced Engineers

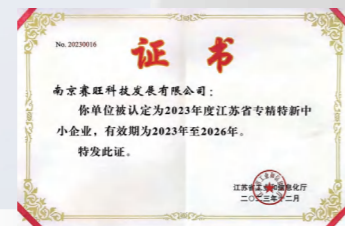
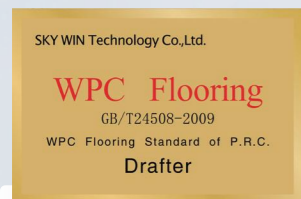

技术参数 Technical Data

型号 Machine Type	挤出机规格 Extruder	制品厚度 (mm) Sheet Thickness	制品宽度 (mm) Sheet Width	主机功率 (kw) Main Motor Power	产量 (kg/hr) Output
SWQB-1	80/156	1.5-8	1220	75	300-450
SWQB-2	92/188	1.5-8	1220	110	500-750
SWQB-3	110/220	1.5-8	1220	200	1000-1500

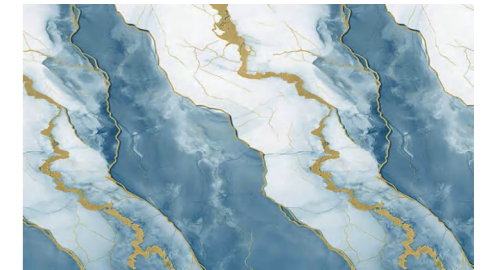
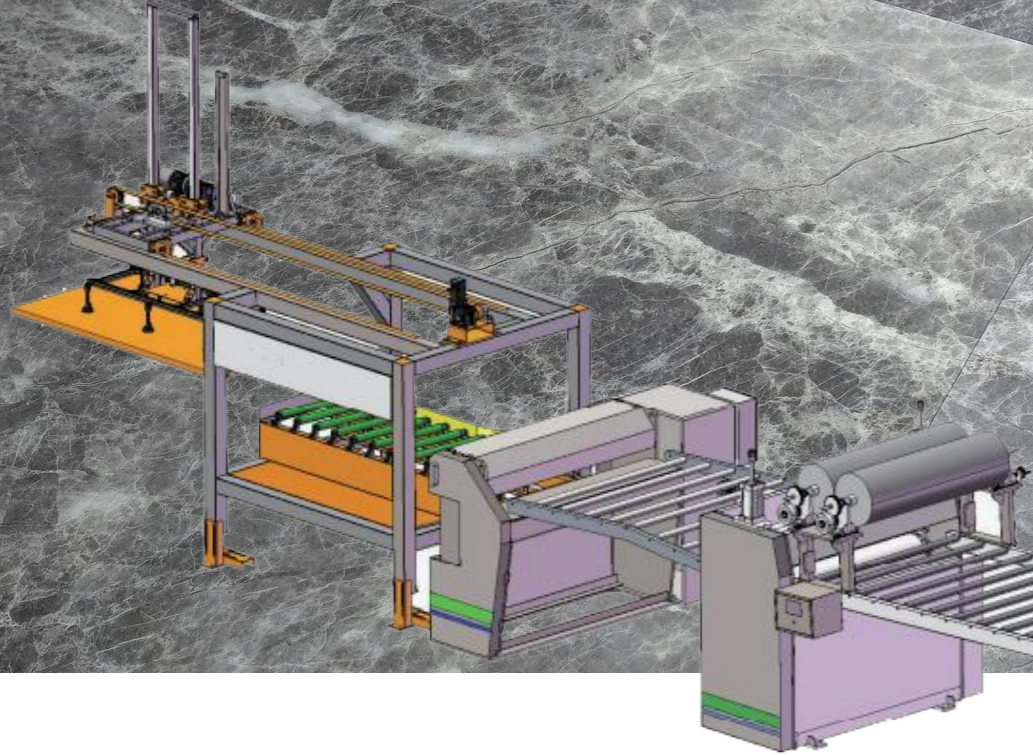
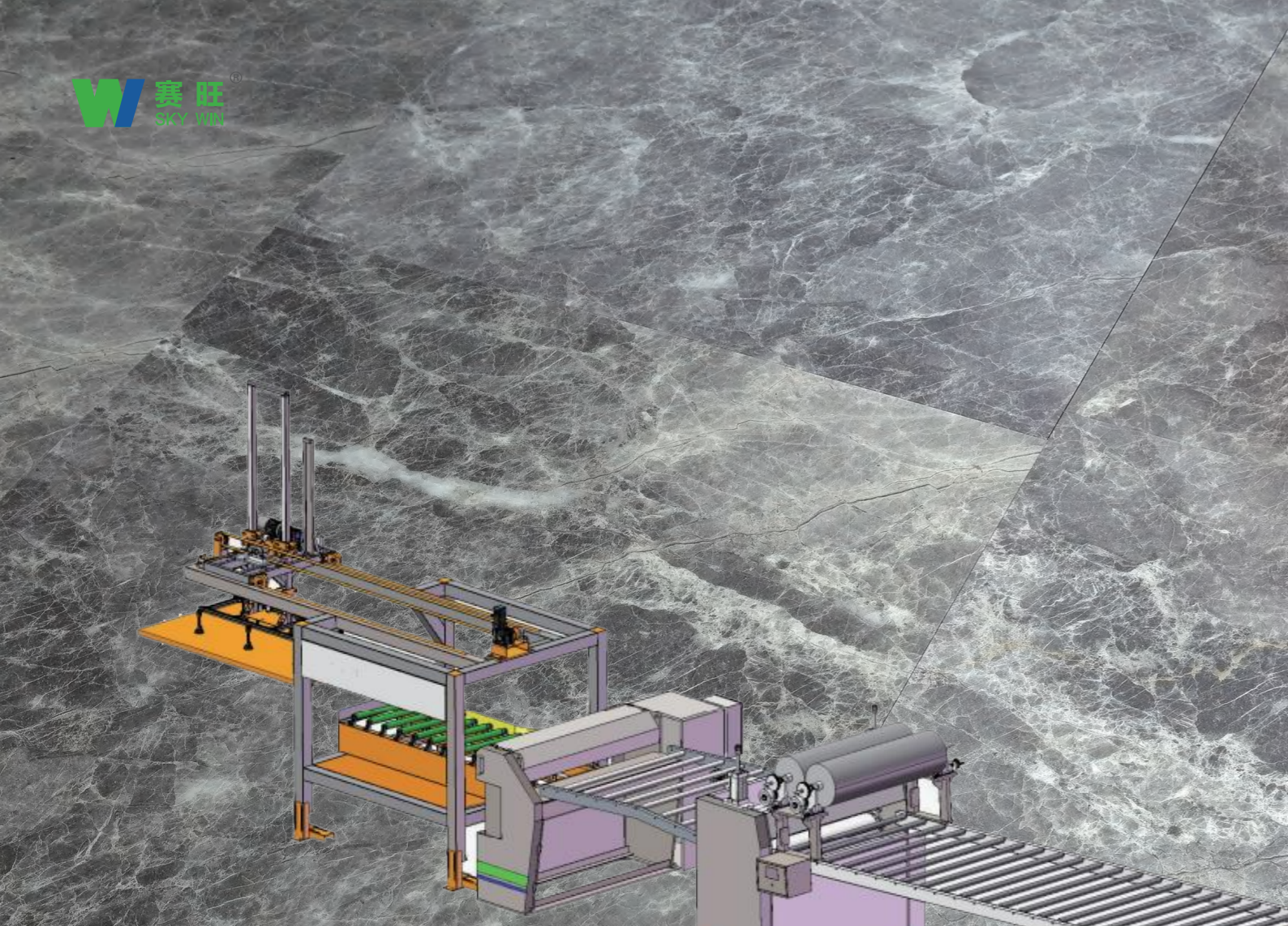

SPC墙板、仿大理石板挤出线

SPC Wall Panel, Imitation Marble Sheet Extrusion Line

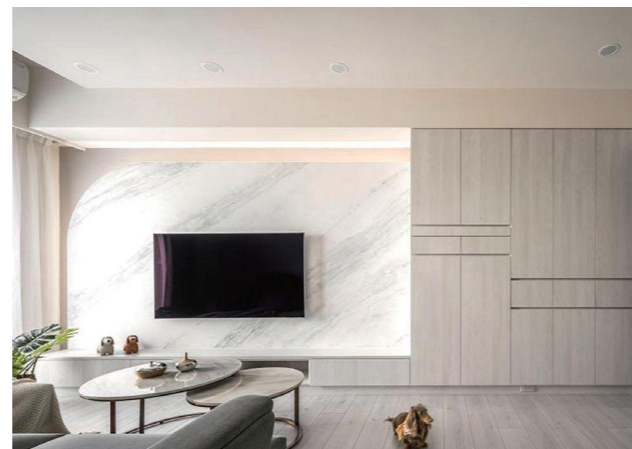
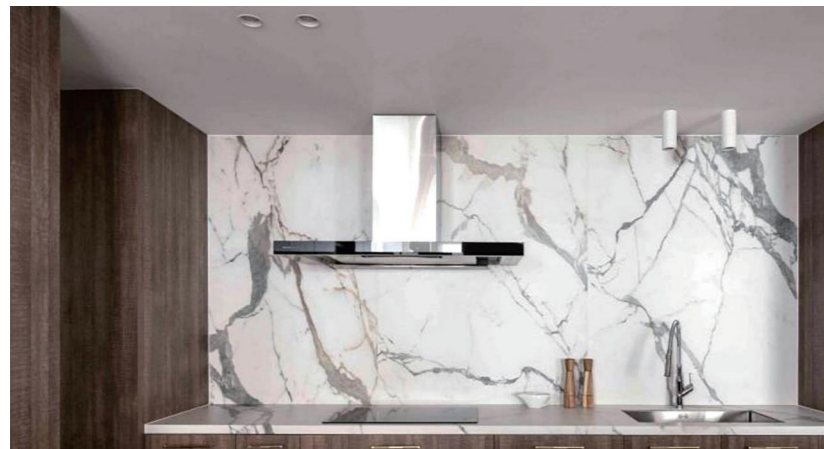
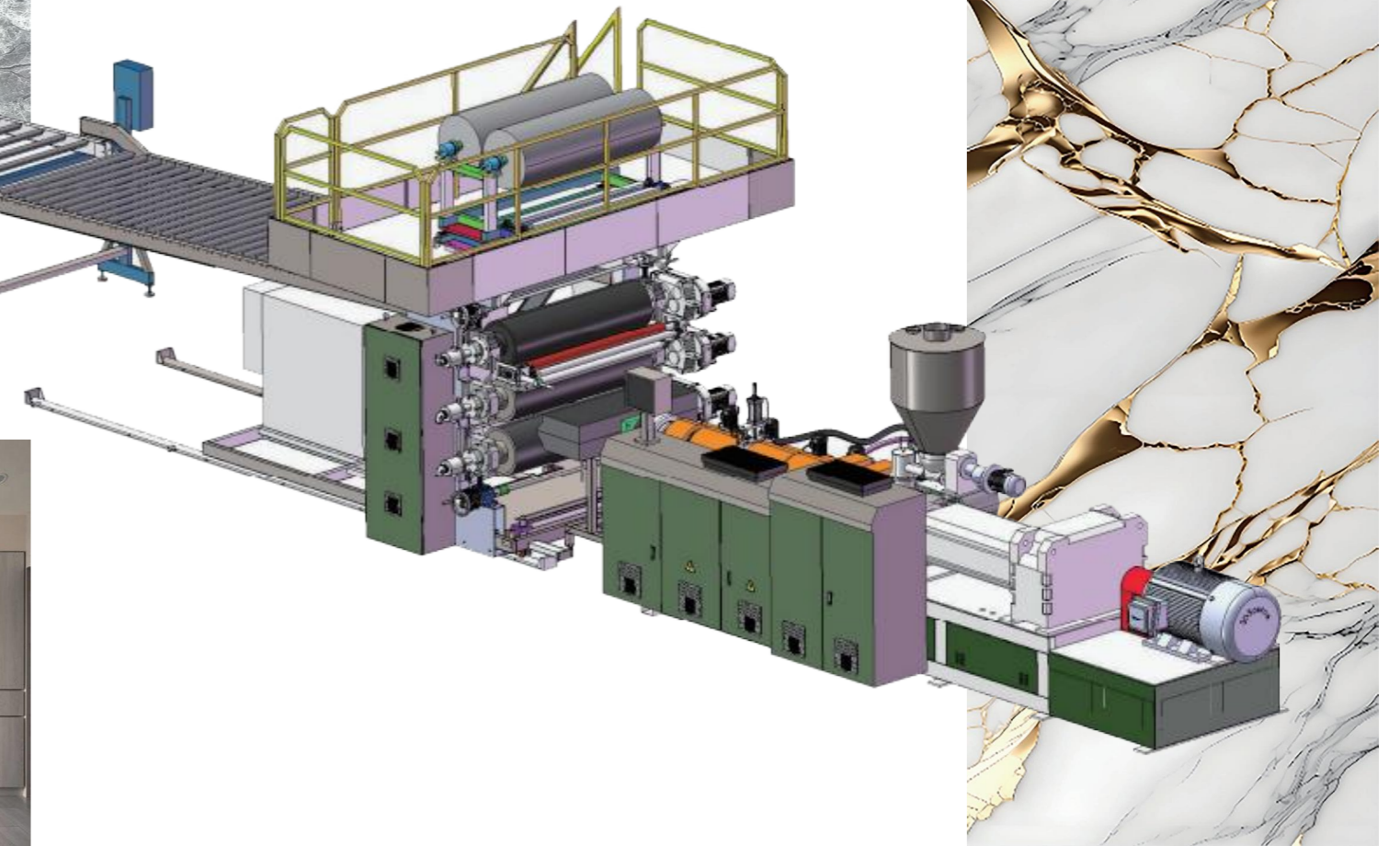



技术参数 Technical Data

型号 Machine Type	挤出机规格 Extruder	制品厚度(mm) Sheet Thickness	制品宽度(mm) Sheet Width	主机功率(KW) Main Motor Power	总功率 (KW) Total Power	产量 (Kg/hr) Output
SWDB5-2	92/188	1.5-7	970-1220	90/110	270	600-800
SWDB5-3	110/220	1.5-7	970-1220	160/200	308/376	1100-1600
SWDB5-3-2	115/232	1.5-7	970-1220	200	400	1500-1800
SWDB5-3-3	125/243	1.5-7	970-1220	200	420	2000-2500
SWDB5-4	132/276	1.5-7	970-1220	280	500	2500-2900
SWDB5-5	150/300	1.5-7	970-1220	315	520	2900-3300
SWDB5-6	182/336	1.5-7	970-1220	450	650	3000-4000

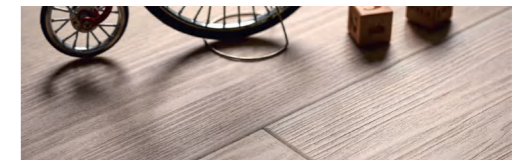
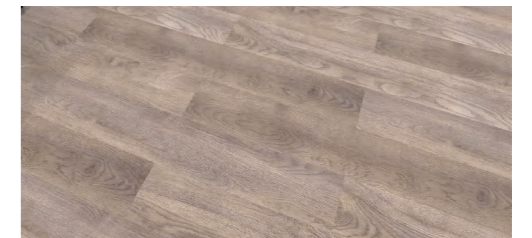

SPC石塑地板五辊挤出线 SPC Flooring Sheet Five-roller Extrusion Line

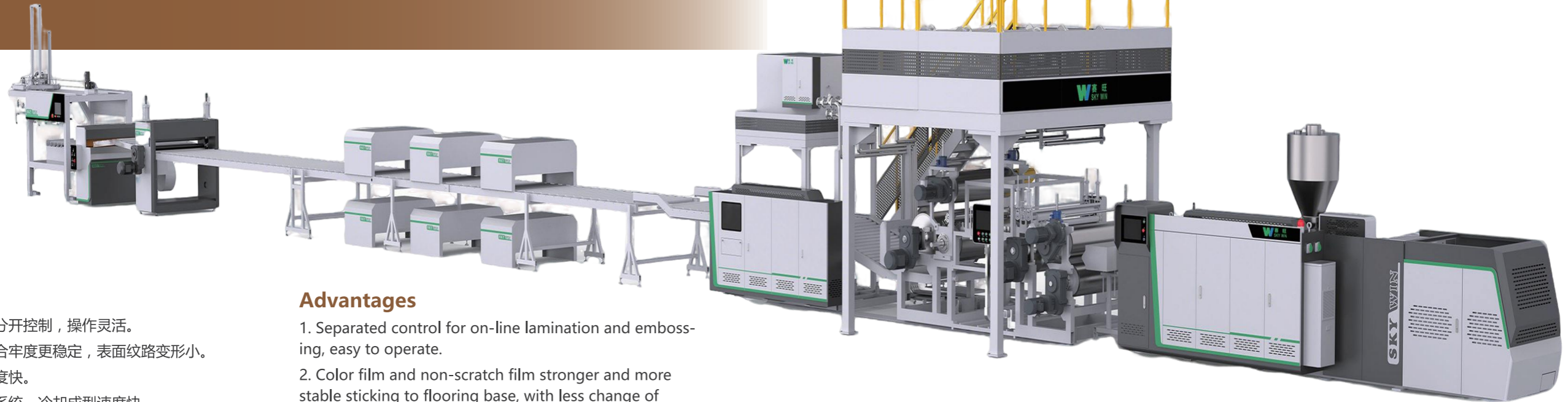

设备优势

- 1、在线覆膜和压纹分开控制，操作灵活。
- 2、彩膜、耐磨层贴合牢度更稳定，表面纹路变形小。
- 3、挤出产量高、速度快。
- 4、采用先进的冷却系统，冷却成型速度快。

Advantages

1. Separated control for on-line lamination and embossing, easy to operate.
2. Color film and non-scratch film stronger and more stable sticking to flooring base, with less change of surface grains.
3. Bigger extruder for bigger extrusion output.
4. Advanced cooling system adopted for better cooling effect suitable for bigger output.

SPC/LVT地板异向平行双螺杆生产线

SPC/LVT Counter-rotate Parallel Twin-screw Extrusion Line

设备优势

- 1、采用高扭矩减速机等国际先进技术，扭矩达到同类减速箱的1.7倍。
- 2、机筒、螺杆采用特殊结构。
- 3、设备能耗小，同等产量可节能20%以上（和锥双比）。

Advantages

1. High-torque gear box adopted with international advanced technology.
2. Screw and barrel with special structure.
3. Lower energy consumption, over 20% compared to conical twin-screw extruder.

技术参数 Technical Data

型号 Machine Type	挤出机规格 Extruder	制品厚度(mm) Sheet Thickness	制品宽度(mm) Sheet Width	主机功率(KW) Main Motor Power	产量 (Kg/hr) Output
SWDBP-1	115/32	1.5-7	970-1220	110	750-1000
SWDBP-2	135/32	1.5-7	970-1220	200	1300-1800
SWDBP-2	160/32	1.5-7	970-1220	280	1800-2500





LVT地板（共挤）挤出设备

LVT Flooring Co-/Extrusion Line

LVT WPC面皮 挤出线

LVT Extrusion Line(WPC Surface)

技术参数 Technical Data

型号 Machine Type	挤出机规格 Extruder	制品厚度(mm) Sheet Thickness	制品宽度(mm) Sheet Width	主机功率(KW) Main Motor Power	产量 (Kg/hr) Output
SWLVT2-1	110/220	0.8-2	1220	200	2500-2800
SWLVT2-2	115/132	0.8-2	1220	200	2800-3000
SWLVT2-3	125/243	0.8-2	1220	200	3000-3500
SWLVT2-4	160/136	0.8-2	1220	280	3500-4500

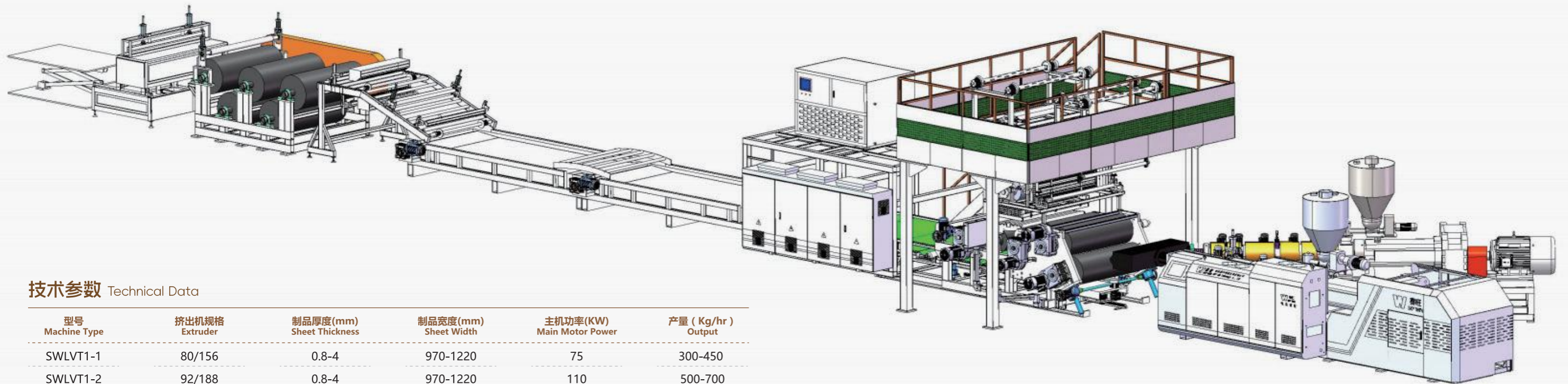

技术参数 Technical Data

型号 Machine Type	挤出机规格 Extruder	制品厚度(mm) Sheet Thickness	制品宽度(mm) Sheet Width	主机功率(KW) Main Motor Power	产量 (Kg/hr) Output
SWLVT1-1	80/156	0.8-4	970-1220	75	300-450
SWLVT1-2	92/188	0.8-4	970-1220	110	500-700
SWLVT1-3	110/220	0.8-4	970-1220	200	800-1200
SWLVT1-4	115/132	0.8-2	970-1220	200	2800-3000

技术参数 Technical Data

型号 Machine Type	挤出机规格 Extruder	制品厚度(mm) Sheet Thickness	制品宽度(mm) Sheet Width	主机功率(KW) Main Motor Power	产量 (Kg/hr) Output
SWGDB-1	92/188	3.2-6.5	1220	110	2000-2500
	80/156			75	
SWGDB-2	110/220	3.2-6.5	1220	200	4000-4500
	92/188			110	
SWGDB-3	125/132	3.2-6.5	1220	200	4500-6000
	110/220			200	

双层LVT+玻纤地板挤出生产线

Double-layer LVT + Fiberglass Flooring Extrusion Line



设备优势

1. 双层结构，稳定性更强
2. 通过共挤的配方调整，解决产品，翘曲和瓦变现象
3. 对比传统压机生产的双层结构LVT产品，成本更低
4. 可在线生产同步对花

Advantages

1. Double-layer structure, stronger stability
2. Solve product warping and warping phenomena through co-extrusion formula adjustment
3. Compared with double-layer structure LVT products produced by traditional presses, the cost is lower
4. With on-line EIR

PVC卷材地板挤出线

PVC roll flooring extrusion line



技术参数 Technical Data

型号 Machine Type	挤出机规格 Extruder	制品厚度(mm) Sheet Thickness	制品宽度(mm) Sheet Width	主机功率(KW) Main Motor Power	产量 (Kg/hr) Output
SWJCD-1	92/188	2-4	2	110	400-700
SWJCD-2	110/220	2-4	2-3	200	800-1200

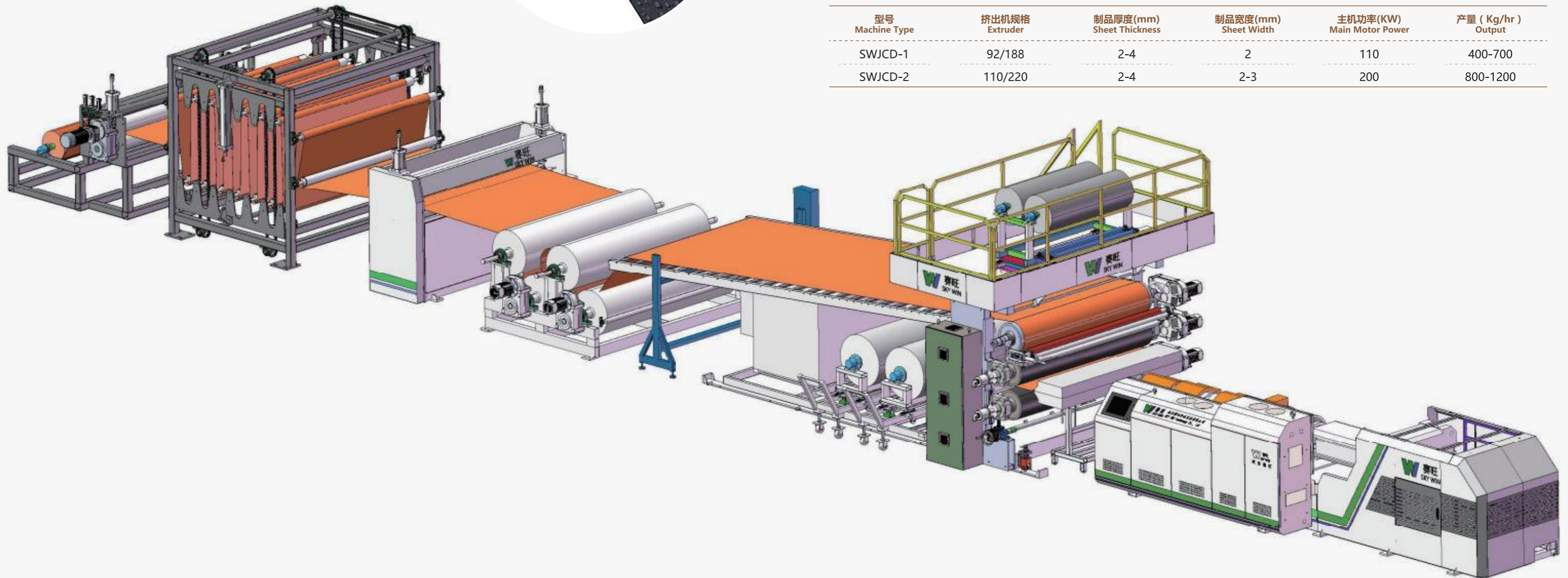

PET(G)地板一步法挤出线

PET(G) Flooring Sheet One-step Extrusion Line

设备优势

1. 可以生产PET新料和回料做的非PVC材料地板
2. 设备产能高，一次性成型、能耗低，国内首创
3. 不含PVC，更环保，真正实现0卤素，0污染，0甲醛，0危害的新型装饰地板

Advantages

1. Can produce non-PVC material floors made of PET new materials and recycled materials
2. High capacity and low energy consumption (without pelletizing), first invented in China
3. Non-PVC environmental protection, a new type of decorative floor that truly achieves zero halogen, zero pollution, zero formaldehyde, and zero hazards.

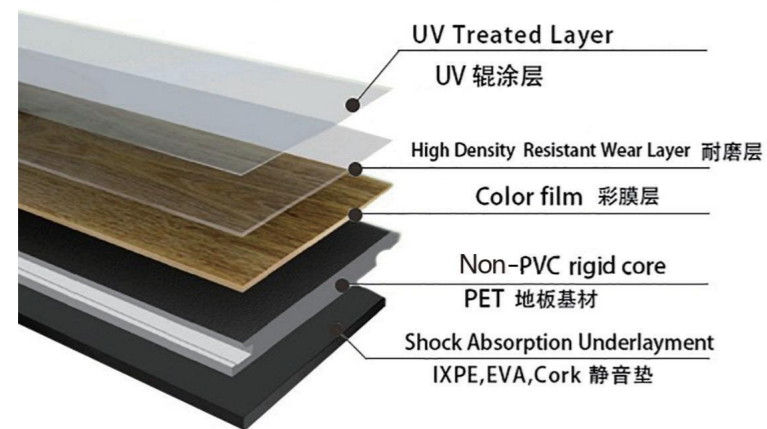

RPET回收料地板挤出线

RPET Recycled Material Flooring Extrusion line



技术参数 Technical Data

型号 Machine Type	挤出机规格 Extruder	制品厚度 (mm) Sheet Thickness	制品宽度 (mm) Sheet Width	主机功率 (kw) Main Motor Power	产量(Ton/day) Output
SWPET-1	155/135	3-6	960-1220	300	30-40
SWNON-1	155/135	3-6	960-1220	300	30-40

LVT-WPC-LVT一步法挤出线

LVT-WPC-LVT One-step Extrusion Line

设备优势

- 1.ABA三层结构，稳定性更强
- 2.通过共挤的配方调整，解决产品，翘曲和瓦变现象
- 3.对比传统WPC发泡地板，成本更低，性能更稳定
- 4.可在线生产同步对花
- 5.可以做多元化产品
- 6.每层的厚度可以单独控制

技术参数 Technical Data

型号 Machine Type	挤出机规格 Extruder	制品厚度(mm) Sheet Thickness	制品宽度(mm) Sheet Width	主机功率(KW) Main Motor Power	产量 (Kg/hr) Output
SWABA-1	92/188	3-8	960-1220	110	2000-2500
	80/156			75	
SWABA-2	110/220	3-8	960-1220	200	3500-4500
	92/188			110	

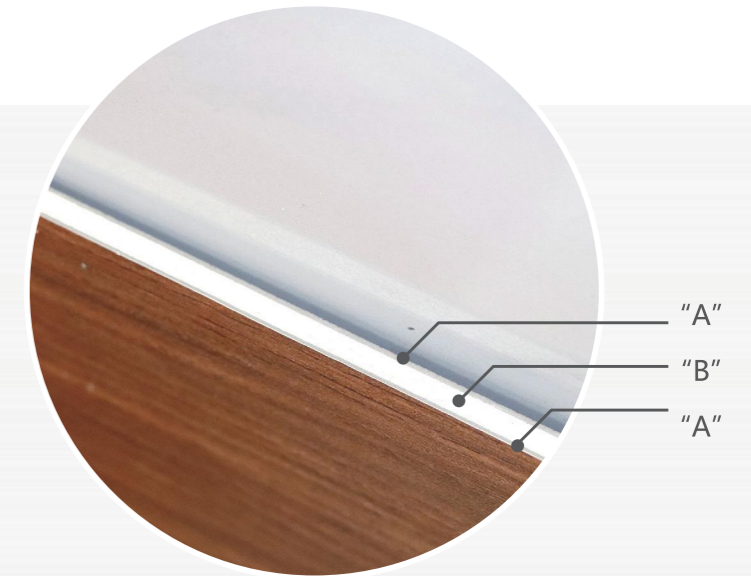

Advantages

- 1.ABA Three-layer structure, stronger stability
2. Solve product warping and warping phenomena through co-extrusion formula adjustment
3. Compared to traditional WPC foam flooring, it has lower costs and more stable performance
4. With on-line EIR
5. Can produce diversified products
6. The thickness of each layer can be controlled separately

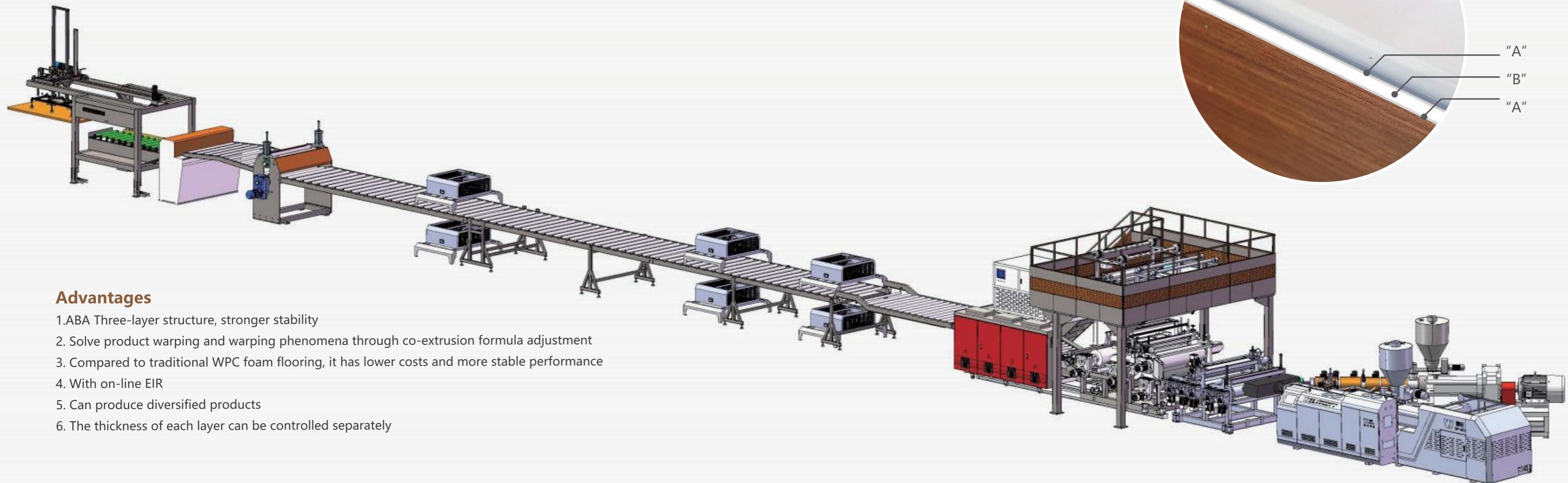



绿色环保木塑地板基材设备

WPC Foamed Sheet Extrusion Line for Flooring Base



技术参数 Technical Data

型号 Machine Type	螺杆直径(mm) Screw Diameter	制品厚度 (mm) Sheet Thickness	制品宽度 (mm) Sheet Width	总功率(KW) Total Power	产量 (kg/hr) Output
SWDJ-1	80/156	600-1200	3-6	75	300-400
SWDJ-2	92/188	600-1200	3-6	110	400-650
SWDJ-3	110/220	600-1200	3-6	200	700-1200

客户案例

CUSTOMER CASE >>>

为客户提供全方位技术服务
With technical support in all aspects!

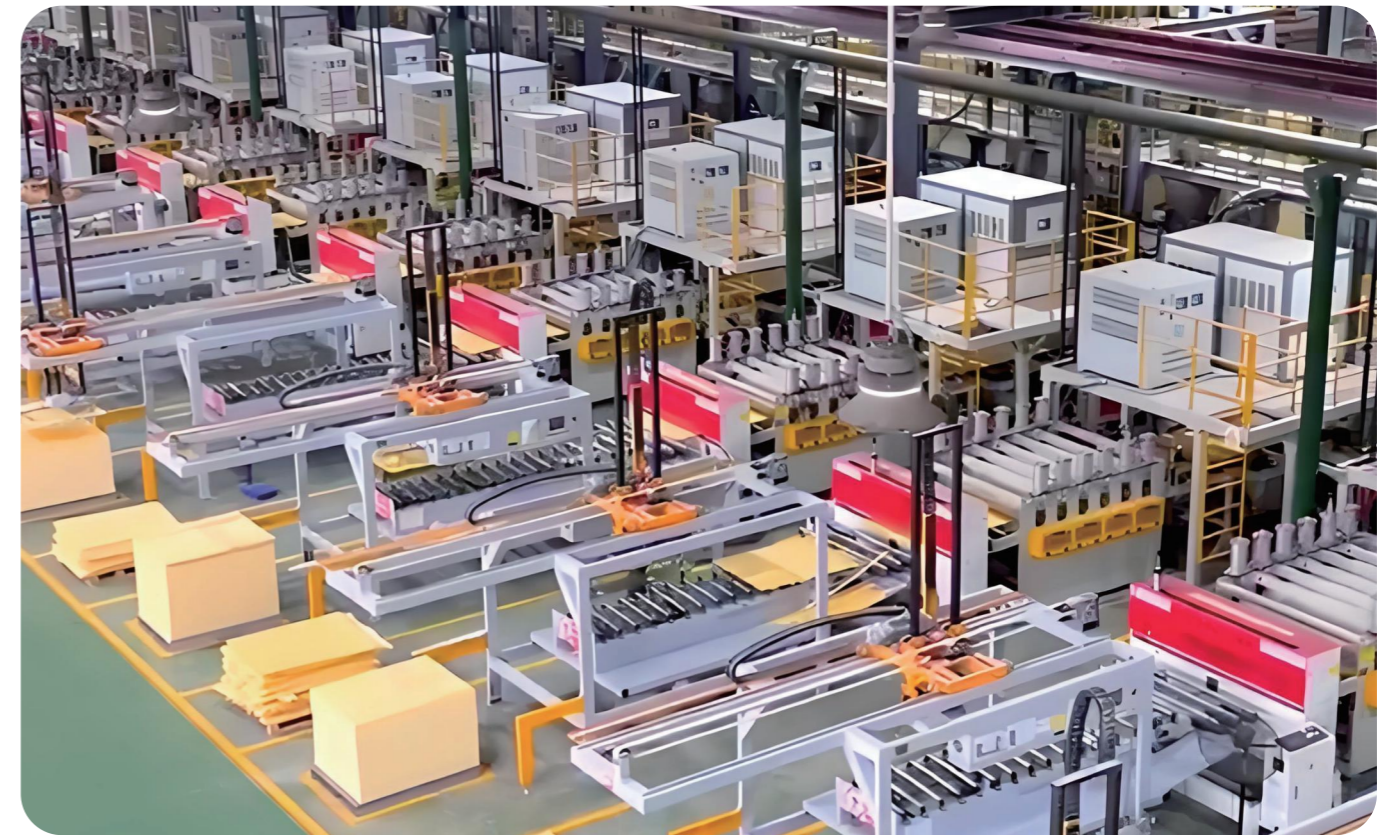

SPC 地板工艺流程
SPC FLOORING PROCESS FLOW

PVC
Type:SG-5

CaCO3
300-500mesh

Slotted ash
grinding
powder

Recycled
material

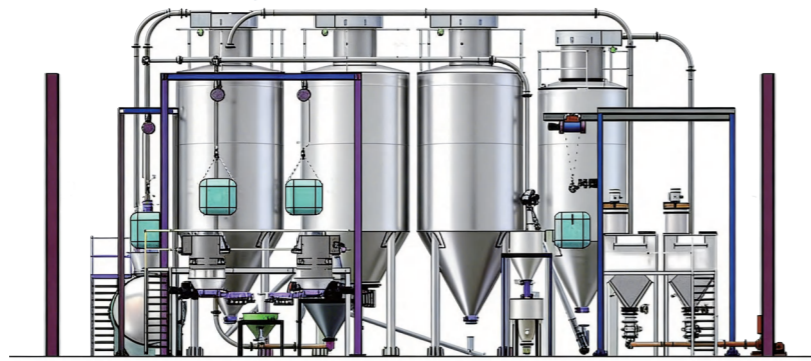

Mixing



Cutting & Slotting



UV

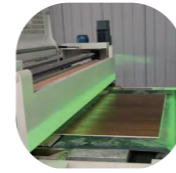

Extruder

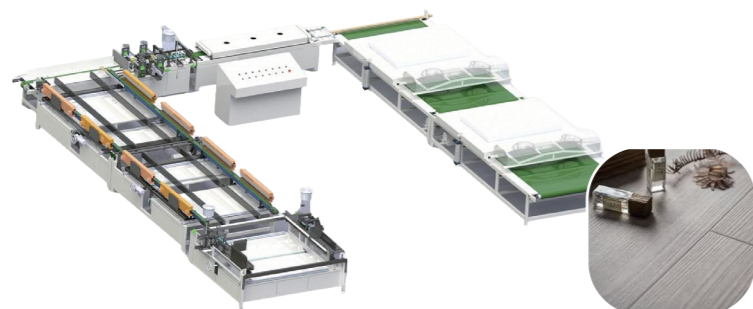

V-Shape Groove Painting

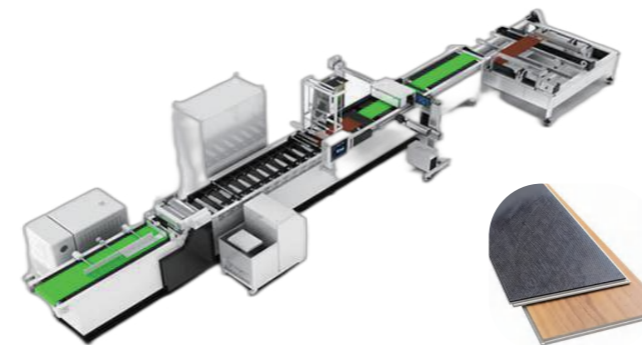

IXPE

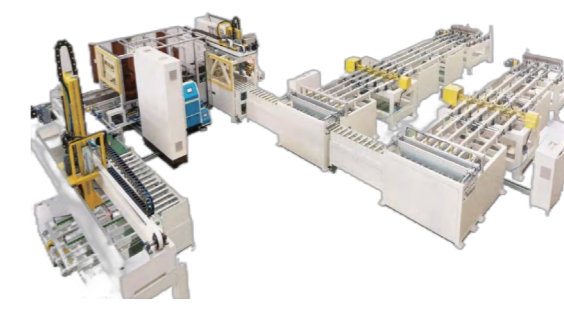
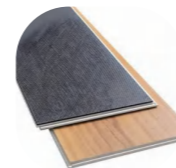

Packing



WPC+LVT地板工艺流程

WPC+LVT FLOORING PROCESS FLOW >>

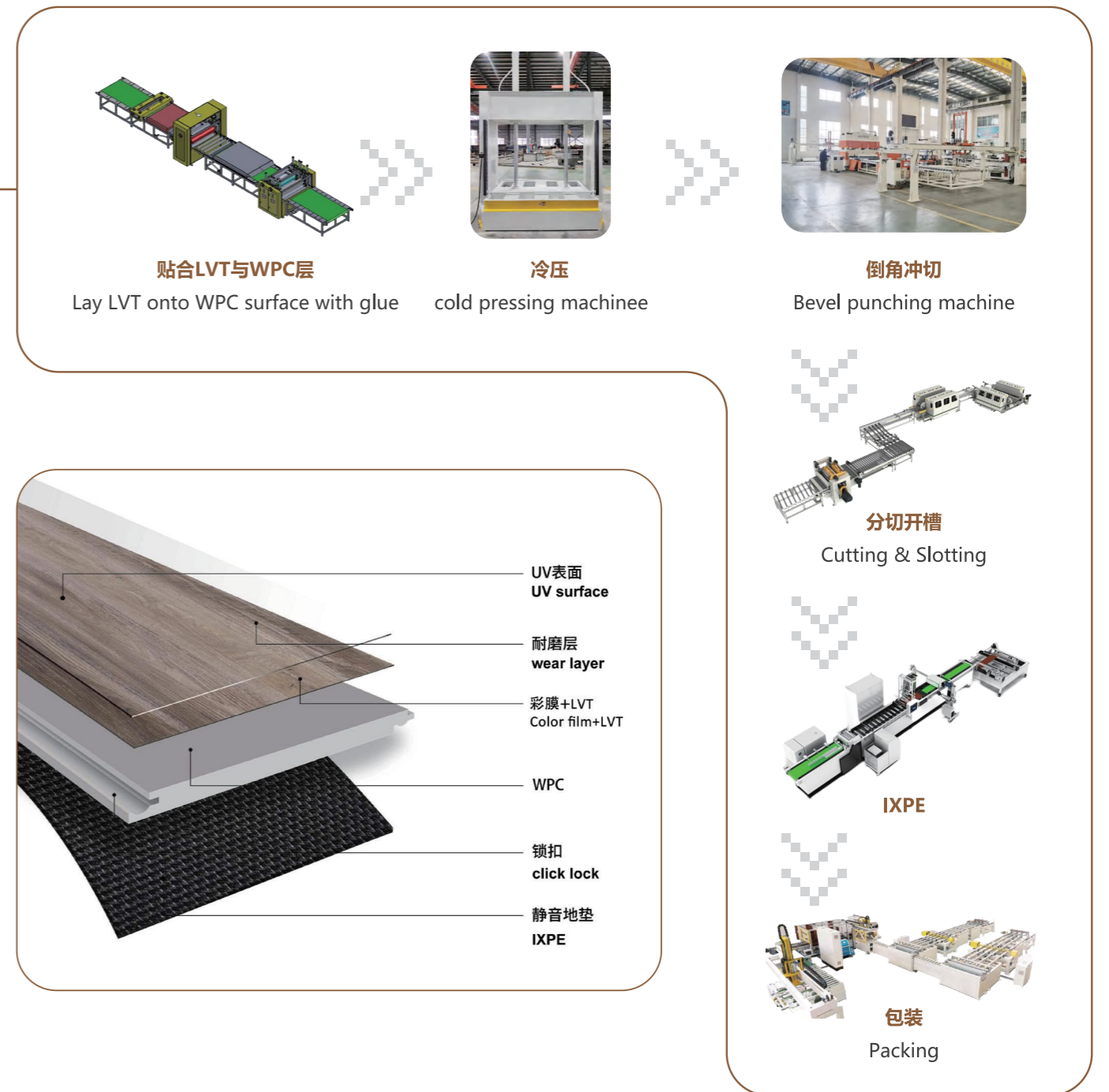
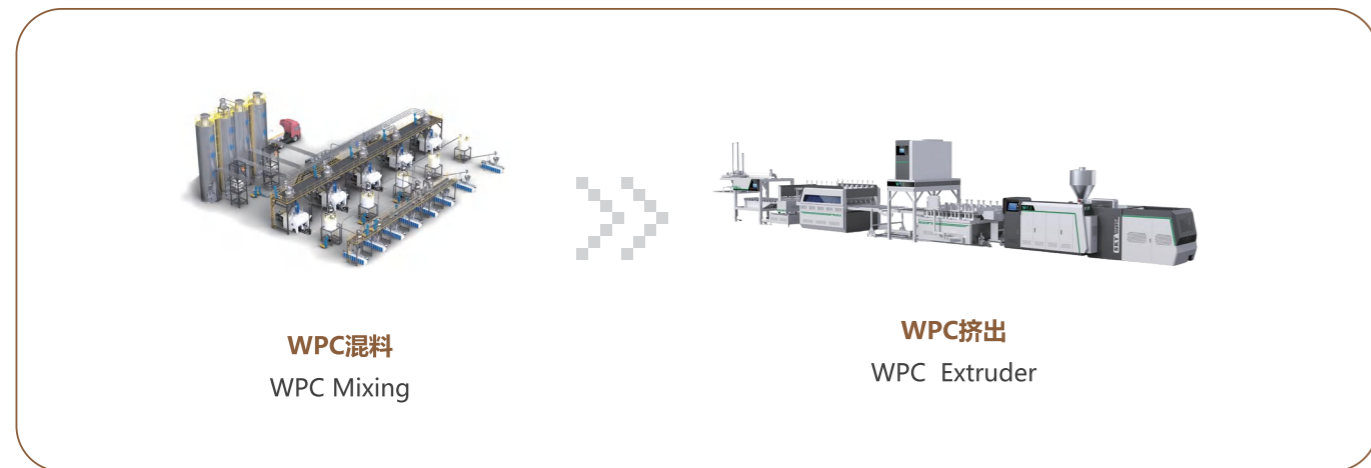
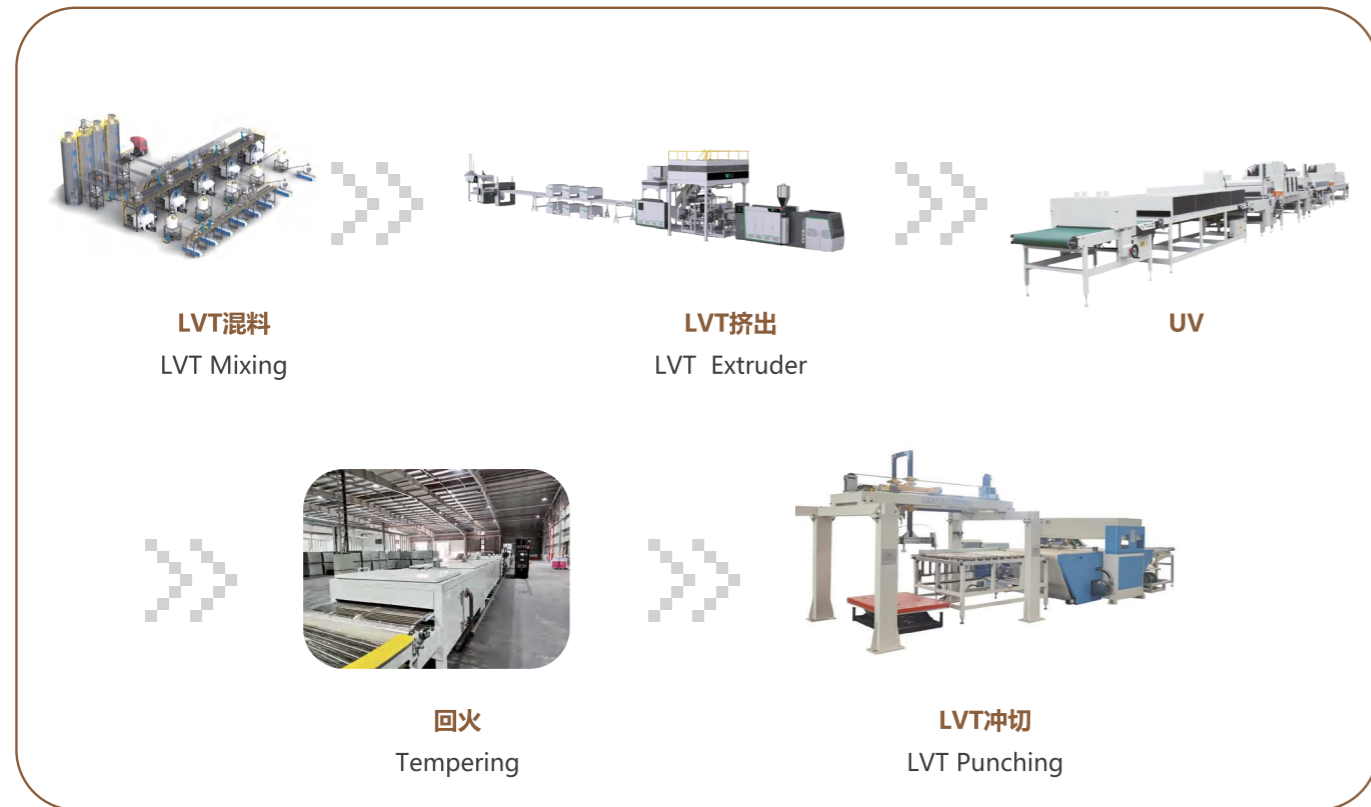

大板破碎、磨粉机

Wide board crushing & grinding machine



地板辅助设备

Upstream and downstream machines for flooring sheet extrusion

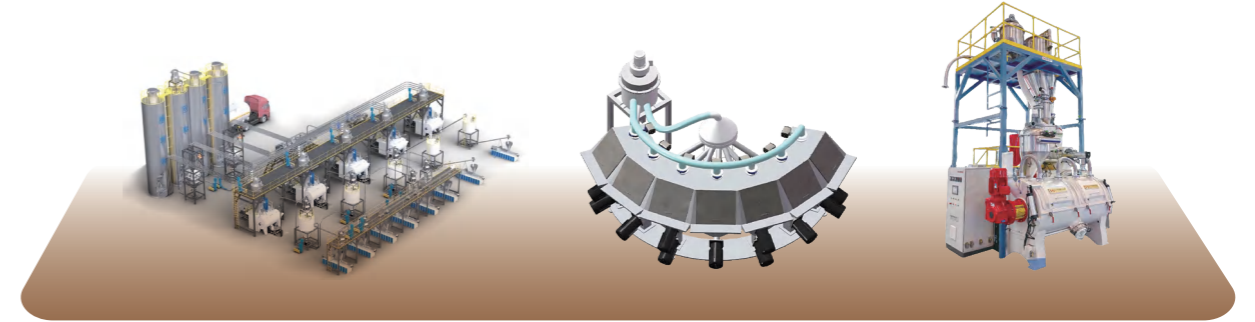

混料自动称量系统
Automatic mixing and weighing system

小料配方机
Additives weighing machine

混料机
Mixing



油温机
Oil tem. controller

冷水机
Chiller

地板后加工设备

Processing Machines for Floor After Extrusion



地板UV辊涂线
UV Coating Machine



单向多片锯
One way multiple blade saw



地板开槽生产线
Slotting machine



静音垫设备
IXPE/EVA Laminator



打包机
Packing machine